

# Honeywell

## Water Purifier

Cold, Hot and Room Temperature Water Dispenser

### OWNER'S MANUAL

Read and save these instructions before use

### Model HWP2013W

For customer service

Please Contact: 1-855-687-2223

#### Mitrana Group HK Ltd.

Suite B, 10/F., Hong Kong Diamond Exchange Building, Nos 8-9 Duddell Street, Central, Hong Kong.

For general inquires about Mitrana Group HK Ltd or Honeywell Water Coolers please contact the toll free number:

1-855-HWHELP1 (1-855-494-3571).

International rates may apply

Or visit: [www.honeywellwatercoolers.com](http://www.honeywellwatercoolers.com)

Imported and Distributed by

SCA Imports LLC

848 Brickell Ave.,

Suite 305, Miami, FL 3313

# Honeywell

© 2017 Mitrana Group HK Ltd. All rights reserved  
IM01-HWP2013W-2017-01

The Honeywell Trademark is used under license from Honeywell International Inc.

Honeywell International Inc. makes no representations or warranties with respect to this product.

The manufacturing of this product is contracted by:  
Mitrana Group HK Ltd

## CONTENTS

1.	Before First Use.....	3
2.	Parts and Features.....	4
3.	Important Safety Instructions.....	6
4.	Installation Guidelines.....	7
5.	Installing your Water Purifier For the First Time.....	8
6.	Instructions for Operating Your Water Purifier.....	11
7.	Sterilization and Filter Replacement function.....	18
8.	Tray Cleaning.....	22
9.	Filters Replacement.....	23
10.	Maintenance.....	26
11.	Technical Specification.....	27
12.	Performance Data Sheet.....	28
13.	Troubleshooting Guide.....	31

## 1. BEFORE FIRTS USE

Read all instructions carefully before setting and operating the unit. Please keep this instruction manual for future reference. This manual is designed to provide you with important information needed to operate and maintain your water purifier. If you don't understand something or need more assistance please contact us. Failure to follow these instructions may damage and/or impair operation and void the warranty.

Keep proof of the original purchase date with this guide to establish the warranty period. Keep a copy of the sales receipt.

Write down the model and serial numbers which can be found on a label located on the side of the water purifier

Please write the information here:

Date of Purchase: \_\_\_\_\_

Model Number: HWP2013W

Serial Number: \_\_\_\_\_

### NOTES

- While testing was performed under standard laboratory conditions, actual performance may vary depending on water pressure, temperatures and other substances, wich may be found in your water.
- It is recommended that, before installing a water purifier, you have you water supply tested to determine your actual water treatment needs.

**WARNING:** BEFORE CONNECTING THE APPLIANCE TO THE POWER SOURCE, LET IT STAND UPRIGHT FOR APPROXIMATELY 24 HOURS. THIS WILL REDUCE THE POSSIBILITY OF A MALFUNCTION IN THE COOLING SYSTEM FROM MISHANDLING DURING DELIVERY.

## 2. PARTS AND FEATURES

This Water Purifier has a powerful filtration system that turns tap water into cleaner water. It dispenses Cold, Room Temperature and Hot water with a flow function that adjusts from 125 cc to 250 cc to non stop flow up to 1 minute, together with an Electrolytic Sterilization System for the inner tubes, the water tank and the faucet. It features a Button Lock and Child Lock to prevent misuse by children, elderly, or persons with reduced capabilities, as well as an Energy Saving function and a Voice Navigation Guide.

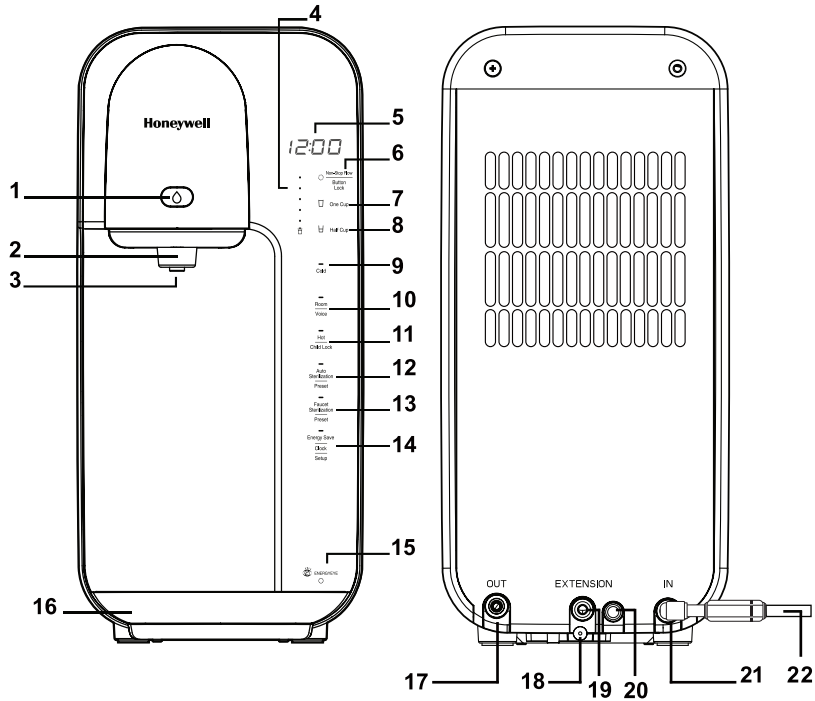

No	Name	No	Name
1	Out Flow Button	12	Automatic Sterilization/Preset Button (Touch) + LED
2	Faucet	13	Faucet Sterilization/Preset Button (Touch) + LED
3	Faucet Lighting LED	14	Energy Saving/Clock/Setting Button (Touch) + LED
4	Cold Water Temperature Display LED	15	Energy-Eye Saving Sensor
5	Clock	16	Tray
6	Non-Stop Flow/Button Lock Button (Touch) + LED	17	Hot/Cold Water Drain
7	One Cup Select Button (Touch) + LED	18	Drain
8	Half Cup Select Button (Touch) + LED	19	External Outlet
9	Cold Water Button (Touch) + LED	20	Power Cord
10	Room Temp. Water/Voice Button (Touch) + LED	21	Tap Water Input
11	Hot Water Lock Button (Touch) + LED 20	22	Water Pressure Valve

## 2. PARTS AND FEATURES

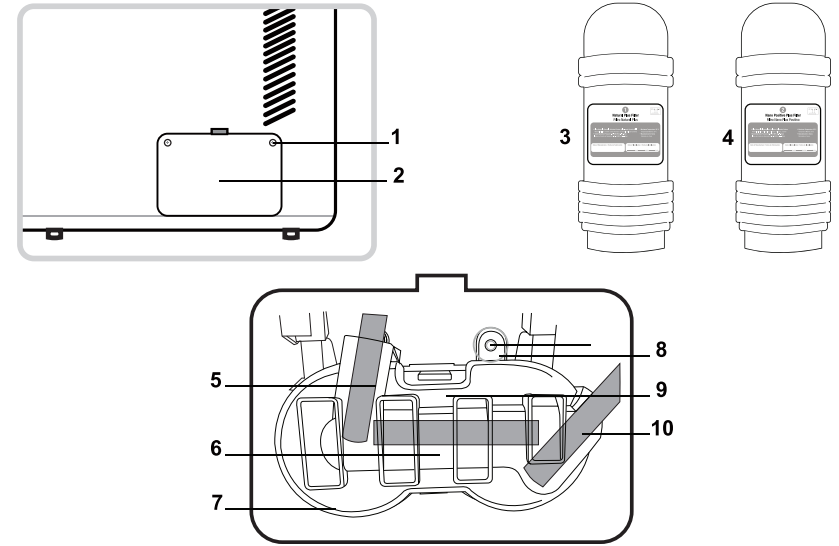

No	Name	No	Name
1	Screw	6	Inter Filter Connector
2	Filter Compartment	7	Transparent Filter Cover
3	Natural Filter Plus (1)	8	Filter Cover Screw
4	Nano Positive Plus Filter (2)	9	Hook
5	Connector 1	10	Connector 2

### ACCESSORIES

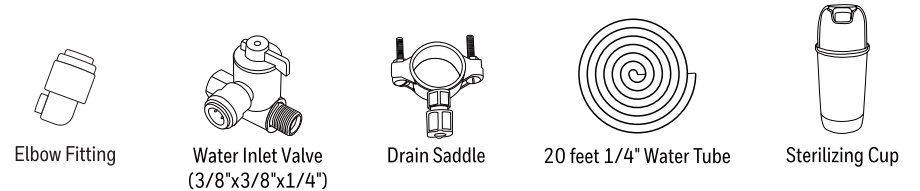

### TOOLS REQUIRED (NOT INCLUDED)

- Drill
- 1/4" Drill Bit (6.35mm)
- Phillips Screwdriver
- Knife or scissors
- Special drill and bit for countertops (may be required)

### 3. IMPORTANT SAFETY INSTRUCTIONS

**WARNING:** To reduce the risk of fire or injury when using this appliance, please follow these basic precautions:

- Read and understand all instructions before using the Water Purifier.
- Your Water Purifier runs on 120 Volt AC, 60 Hz current. Do not plug this product to 220V current.
- Before operating the product remove it from its packaging and check if it is in good condition.
- DO NOT operate any product with a damaged cord or plug. Using an extension cord is not recommended with this appliance.
- **GROUNDING INSTRUCTIONS:** This appliance must be grounded. In the event of a malfunction or breakdown, grounding will reduce the risk of electric shock by providing a path of least resistance for electric current. This appliance is equipped with a cord having an appliance-grounding conductor and a grounding plug. The plug must be plugged into an appropriate outlet that is installed and grounded in accordance with all local codes and ordinances.

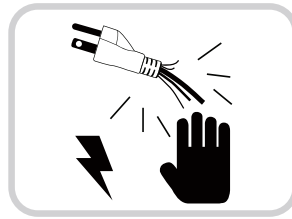
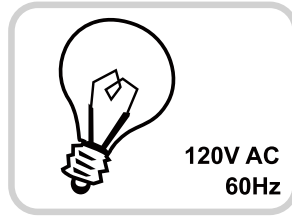

- WARNING:** Improper connection of the appliance-grounding conductor can result in a risk of electric shock. Check with a qualified electrician or service representative if you are in doubt whether the appliance is properly grounded. Do not modify the plug provided with the appliance; if it will not fit the outlet, have a proper outlet installed by a qualified technician.
- Make sure the power cord is not under a heavy object or near sharp objects.
  - In case of water leak or cleaning, first close the Tap Water Supply Valve, and then pull out the Plug.
  - Always unplug the appliance from the power source before cleaning, servicing or relocating the unit.
  - Remove the power cord from the electrical receptacle by grasping and pulling on the power cord plug-end only, never pull the cord.
  - DO NOT attempt to repair or adjust any electrical or mechanical functions of the unit, as this may void the warranty.
  - DO NOT let children play with this appliance, packaging or plastic bags.
  - DO NOT place the appliance in an area with potential for gas leak or near a heating device.
  - DO NOT move the unit during operation.
  - If the product is damaged or it malfunctions, do not continue to operate it. Refer to the troubleshooting section and/or call Customer Service

### 3. IMPORTANT SAFETY INSTRUCTIONS

- Never locate the product where it may fall into a bathtub, sink, or other water filled containers.
- DO NOT use in bathrooms or outdoors.
- Never locate the product where it may fall into a bathtub, sink, or other water filled containers.
- DO NOT use in bathrooms or outdoors.
- This appliance is not intended for use by persons (including children or elderly) with reduced physical, sensory or mental capabilities, or lack of experience and knowledge, unless they have been given supervision or instruction concerning the use of the appliance by a person responsible for their safety.
- Never clean the parts with flammable fluids. The fumes can create a fire hazard or explosion.
- DO NOT store or use gasoline or any other flammable vapors and liquids in the vicinity of this or any other water dispenser. The fumes can create a fire hazard or explosion.
- Keep this Owner's Manual handy for future reference.

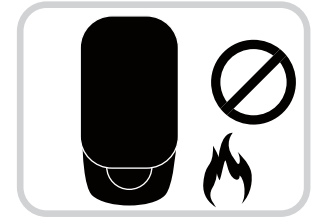

### 4. INSTALLATION GUIDELINES

- Remove the exterior and interior packing.
- This product is for indoor use only and must be installed in a cool, ventilated area.
- Place the unit on a level surface.
- Keep area around the unit free of dust and dirt.
- Locate the unit away from direct sunlight and sources of heat (stove, heater, radiator, etc.).
- Avoid direct sunlight as it may affect the unit over time and heat sources may increase electrical consumption.
- DO NOT locate this product in areas where the temperature may fall below freezing (32°F/0°C).
- Before installing your Water Purifier please make sure that it is turned off, unplugged from its power source and drained.

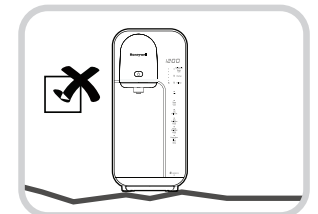
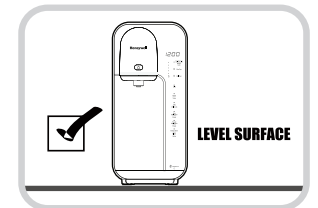

**WARNING:** Using a plugged Water Purifier WITHOUT water, can cause smoke and malfunction.

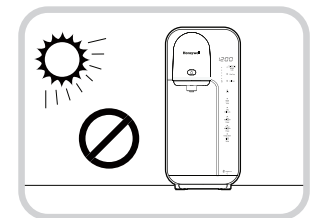



## 5. INSTALLING YOUR WATER PURIFIER FOR THE FIRST TIME

**WARNING:** Use these instructions as reference only, as assembly may be different in each user's location. Seek professional help if you are unable to follow these instructions. Drilling is required.

**WARNING:** Make sure there is an opening on the sink or countertop of at least 1" in diameter to run the water tubes from the Purifier to the water connections below the sink, otherwise drilling a hole on top of the sink or the countertop may be required. Seek professional help if you are unable to perform this task.

**WARNING:** The water used for the inspection process during product manufacturing may still remain inside. Although clean filtered water was used to inspect the unit, please run the Instant Automatic Sterilization Function before drinking water for the first time.

**WARNING:** DO NOT use water other than tap water from the waterworks.

1. Close the cold water tap (Fig. 1).

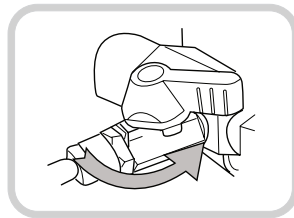

Fig. 1

2. Detach the hose connected from the cold water tap to the sink (Fig. 2).

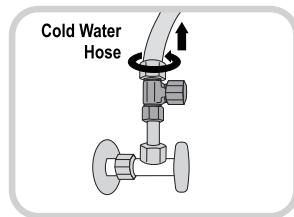

Fig. 2

3. Install the Water Inlet Valve on one end directly to the cold water tap and attach the hose to the other end. The valve now becomes a bypass between the cold water tap and the hose that runs to the sink (Fig. 3).

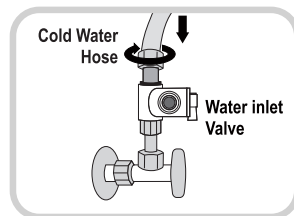

Fig. 3

## 5. INSTALLING YOUR WATER PURIFIER FOR THE FIRST TIME

4. Use a drill with a 1/4" Drill Bit to drill a hole on one side of the Drain Pipe and attach the Drain Saddle using a Phillips screwdriver. (Fig. 4).
5. Using a knife or scissors cut a segment of the 1/4" Water Tube long enough to connect the Purifier to the Water Inlet Valve located under the sink. Leave a few additional inches of the tube to allow rotation of the unit when installing, maintaining or changing the filters. Connect one end of the Water Tube to the quick connector of the Water Inlet Valve. Connect the other end to the Water Pressure Valve of the Water Inlet (IN) located at the back of the unit (Fig. 4) (Fig. 5).

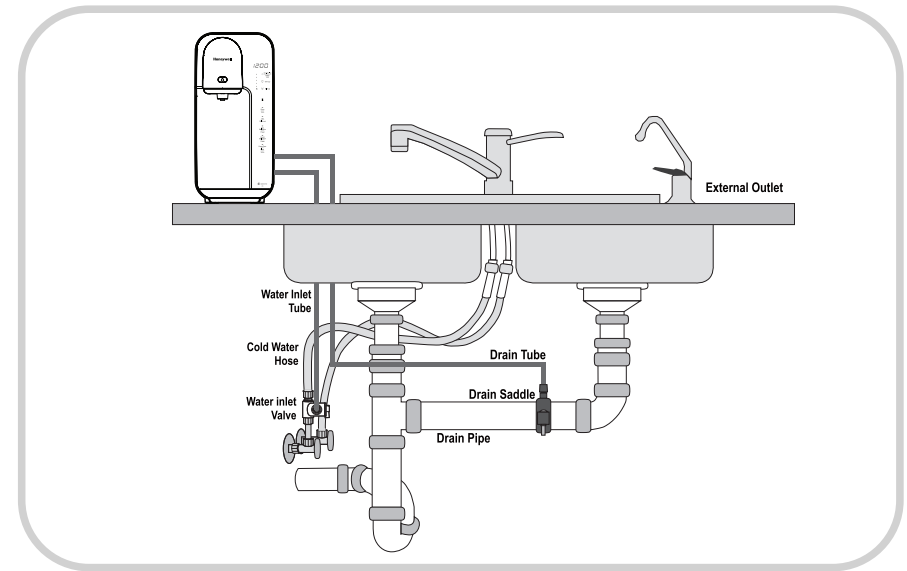

Fig. 4

6. Using a knife or scissors (not included) cut a segment from the 1/4" Water Tube long enough to connect the Purifier to the Drain Saddle located under the sink. Leave a few additional inches of the tube to allow rotation of the unit when installing, maintaining or changing the filters. Connect one end of the Water Tube to the quick connector of the Drain Saddle. Connect the other end to the quick connector of the Elbow Fitting on the Water Outlet located at the back of the unit (Fig. 4) (Fig. 5).

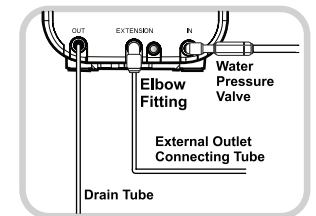

Fig. 5

## 5. INSTALLING YOUR WATER PURIFIER FOR THE FIRST TIME

### NOTES

- A. Make sure the Water Tubes are firmly connected to all ends by gently pulling on each side. The tubes should not detach.
  - B. DO NOT connect the Purifier farther than 9.8 feet (3 meters) from the Drain Pipe.
  - C. DO NOT place the Drain Tube higher than the surface where the product is installed.
  - D. The connection to the Drain Pipe should not be higher than 17.7 inches (45 cm) above the floor if the Drain Tube is touching the floor.
7. Use the EXTENSION option on the back of the unit if you have an external outlet on the sink. An additional water valve may be required (not included). Proceed the same way as described in steps 5 to 6 using the EXTENSION outlet at the back of the unit. (Fig. 4) (Fig. 5) (Fig. 6).
  8. Open the cold water tap and check if there is water leakage on each connecting part (Water Inlet Valve, Drain Saddle and Purifier connections). (Fig 7).
  9. Connect to the power supply. This product runs on 120 Volt AC, 60 Hz current. Do not plug this product to 220V current. (Fig. 8).
  10. Run the Drainage Function and Instant Automatic Sterilization detailed in pages 18 and 19 respectively.
  11. Your Water Purifier is ready to be used. Please allow approximately one hour for the Water Purifier to be ready to dispense cold water.

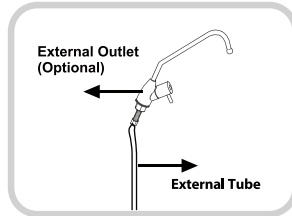

Fig. 6

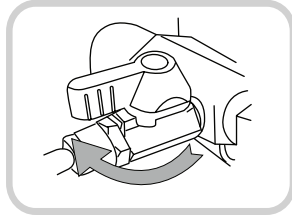

Fig. 7

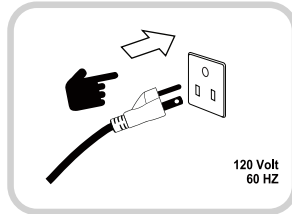

Fig. 8

## 6. INSTRUCTIONS FOR OPERATING YOUR WATER PURIFIER

### TERMINOLOGY

1. **Waiting Status**
  - It is an Out Flow Waiting mode for dispensing Cold Water, Room Temperature Water and Hot Water. The Display Lamps on the front will turn ON according to the selected function and will display the current time.
2. **User Setting Mode**
  - You can set the function by pressing the Energy Save/Clock (Setup) button for three (3) seconds in the Waiting Status.
  - If no action is taken after starting the User Setting Mode, the unit will go back to the Waiting Status and the Voice Guide will say "function set up canceled due to time out".

#### User Setting Mode

Button	Function
Non-Stop Flow/Button Lock	Drainage Function
One Cup	One Cup Out Flow Setting Function
Half Cup	Half Cup Out Flow Setting Function
Cold Water	Cold Water ON/OFF Function
Room Water/Voice	Voice Volume Setting Function
Hot Water/Hot Water Lock	Mood Lamp ON/OFF Function
Automatic Sterilization/Preset	Cold Water Circulating Pump ON/OFF Function
Energy Save/Clock (Setup)	Clock Setting Function
Out Flow	Automatic Filter Cleaning Function

3. **Fixed Dispensing Volume**
  - Press the Out Flow button once and the selected fixed amount of water will be dispensed.
  - Select the Half Cup button and press the Out Flow button to dispense approximately 125cc.
  - Select the One Cup button and press the Out Flow button to dispense approximately 250cc.
  - Select the Non-Stop Flow/Button Lock button and press the Out Flow button, and the water will be dispensed for 60 seconds.
4. **Manual Out Flow**
  - The water is dispensed while pressing the Out Flow button.
  - Press the Out Flow button for two (2) seconds, and the Water Purifier will turn into the Manual Out Flow status and the water will be dispensed while pressing the Out Flow button.

## 6. INSTRUCTIONS FOR OPERATING YOUR WATER PURIFIER

### COLD WATER FUNCTION

1. The Cold Water function is set to be ON as default on the product. If the Cold Water Function is not ON but OFF, press the Cold button for four (4) seconds to turn ON the Cold Water Function. (Fig. 1).
  - While pressing the Cold button, the Voice Guide will say "selecting cold water function".
  - When the Cold Water function is turned ON, the word ON will be displayed and the Voice Guide will say "cold water function selected".
2. If you do not want to use the cold water, turn OFF the Cold Water function by pressing the Cold button for four (4) seconds while the Cold Water function is ON.
  - While pressing the Cold button, the Voice Guide will say "cancelling cold water function".
  - When the Cold Water function is turned OFF, the word OFF will be displayed and the Voice Guide will say "cold water function cancelled".
  - If the Cold button is pressed while the Cold Water function is OFF, the Voice Guide will say "cold water function off" "please turn ON cold water function before use".
3. Cold water will be dispensed in approximately one (1) hour after the Cold Water function has been turned ON.

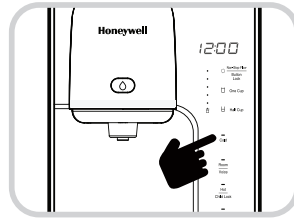

Fig. 1

### CHILD LOCK FUNCTION

This function is used both to protect children as for safety. When the function is selected, the input of Hot/Hot Water Lock button will be blocked and it will not dispense hot water.

1. If the Hot/Hot Water Lock button is pressed for three (3) seconds in the Waiting status, the Hot Water Lock will be selected. (Fig. 2).
  - If the Hot/Hot Water Lock button is in the Hot Water Lock status, hot water can not be selected.
  - If the Hot/Hot Water Lock button is pressed for three (3) seconds in the Hot Water Lock status, the word Un-Lock will be displayed and the Hot Water Lock will be released.

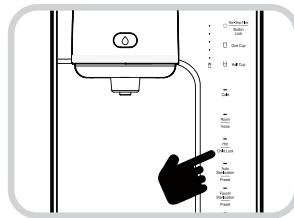

Fig. 2

## 6. INSTRUCTIONS FOR OPERATING YOUR WATER PURIFIER

### DISPENSING COLD WATER

1. Check if the Cold Display Lamp is ON and press the Cold button. (Fig. 3).
  - The Voice Guide will say "cold water".
2. In order to use the Fixed Dispensing Volume:
  - Select the desired amount of water among the buttons Half Cup, One Cup and Non-Stop Flow/Buton Lock.
  - Press the Out Flow button once. Cold water will be dispensed.
  - Once the selected amount of water is dispensed, water dispensing will stop.
  - If the Out Flow button or the selected fixed amount of water button is pressed while the fixed amount of water is dispensed, water dispensing will stop.
3. Operating the Manual Out Flow
  - Press the Out Flow button. Cold water will be dispensed.
  - Keep pressing the Out Flow button for two (2) seconds or longer to turn the out flow into Manual Out Flow status.
  - The Voice Guide will say "water dispensing during pressing".
  - Stop pressing the Out Flow button during the Manual Outflow and water dispensing will stop.
4. While dispensing cold water, the Blue Mood Lamp on the Faucet will turn ON. If the Mood function is OFF, the Lamp will not turn ON.

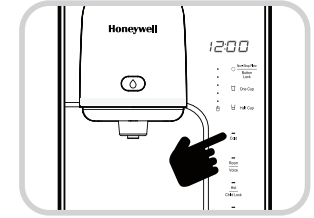

Fig. 3

### DISPENSING ROOM TEMPERATURE WATER

1. Check if the Room water/Voice Display Lamp is ON and press the Room water/Voice button. (Fig. 4).
  - The Voice Guide will say "room temperature water".
2. In order to use the fixed Dispensing Volume:
  - Select the desired amount among the buttons of Half Cup, One Cup and Non-Stop Flow/Buton Lock.
  - Press the Out Flow button once. Room Temperature water will be dispensed.
  - When the selected amount of water has been dispensed, water dispensing will stop.

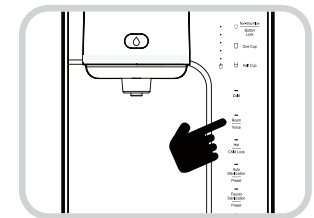

Fig. 4

## 6. INSTRUCTIONS FOR OPERATING YOUR WATER PURIFIER

- If the Out Flow button or the selected fixed amount of water button is pressed again while the fixed amount of water is dispensed, water dispensing will stop.
3. To operate the Manual Out Flow:
    - Press the Out Flow button. Room Temperature water will be dispensed.
    - Keep pressing the Out Flow button for two (2) seconds or more and the out flow will change to Manual Out Flow status.
    - The Voice Guide will say "water dispensing during pressing".
    - Stop pressing the Out Flow button during the Manual Out Flow and water dispensing will stop.
  4. While dispensing room temperature water, the Green Mood Lamp on the Faucet will turn ON. If the Mood function is OFF, the Lamp will not turn ON.

### DISPENSING HOT WATER

1. Select the hot water by pressing the Hot/Hot Water Lock button. (Fig. 5).
  - Press the Hot/Hot Water Lock button, the Hot/Hot Water Lock button Display Lamp will turn ON.
  - The Voice Guide will say "hot water".
2. In order to use the fixed Dispensing Volume:
  - Select the desired amount among the buttons of Half Cup, One Cup and Non-Stop Flow/Button Lock.
  - Press the Out Flow button once. After preheating, hot water will be dispensed.
  - When the selected amount of water has been dispensed, water dispensing will stop.
  - If the Out Flow button or the selected fixed amount of water button is pressed again while the fixed amount of water is dispensed, water dispensing will stop.
3. To operate the Manual Out Flow:
  - Press the Out Flow button. After preheating, hot water will be dispensed.
  - Keep pressing the Out Flow button for two (2) seconds or more and the out flow will change to Manual Out Flow status.
  - The Voice Guide will say "water dispensing during pressing".
  - Stop pressing the Out Flow button during the Manual Out Flow and water dispensing will stop.

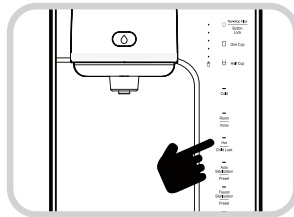

Fig. 5

## 6. INSTRUCTIONS FOR OPERATING YOUR WATER PURIFIER

4. While dispensing hot water, the Red Mood Lamp on the Faucet will turn ON. If the Mood function is OFF, the Lamp will not turn ON.

### CHANGING DISPENSING VOLUME

1. Press the Energy Save/Clock (Setup) button for three seconds. (Fig. 6). The Voice Guide will say "selecting user setting mode". "user setting mode, please set function by pressing the illuminated button".
  - The product will be in the User Setting mode.
2. Set the desired amount of out flow by pressing the One Cup or Half Cup. (Fig. 7) (Fig. 8).
  - Each time the button is pressed, the Display will keep changing from 0 (Standard) to Up and Down.

Example: 8880 → 8808 → 8888

Fixed Quantity	Quantity of Out Flow (cc)		
	Down	Standart	Up
Half Cup	About 110 cc	About 125 cc	About 170 cc
One Cup	About 210 cc	About 250 cc	About 290 cc

3. Select the desired amount of out flow and save it by pressing the Energy Save/Clock (Setup) button. (Fig. 6)
  - The Voice Guide will say "setup completed".

### ENERGY SAVE FUNCTION

1. Press The Energy Save/Clock (Setup) button while the Energy Save/Clock (Setup) Display Lamp is OFF. (Fig. 6).
  - The Energy Save/Clock (Setup) Display Lamp will turn ON and in one second all Display Lamps will be dark.
  - The Voice Guide will say "energy-eye function selected".
  - The Energy Save function will turn OFF all Display Lamps other than the Out Flow Display Lamp and the Mood Lamp when the Night Sensor has sensed darkness for a certain time.
  - If the Energy Save function is ON and the button is pressed, the Display Lamps will be bright. If the button is not pressed for a certain time, the Display Lamps will be dark again.
2. Press the Energy Save/Clock (Setup) button while the Energy Save/Clock (Setup) Display Lamp is ON to cancel the Energy Save function.
  - The Energy Save/Clock (Setup) Display Lamp will turn OFF and all Display Lamps will be bright.
  - The Voice Guide will say "energy-eye function cancelled".

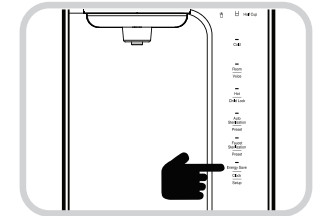

Fig. 6

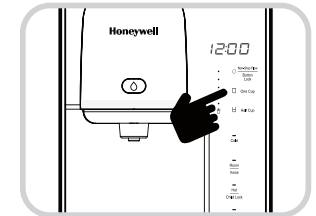

Fig. 7

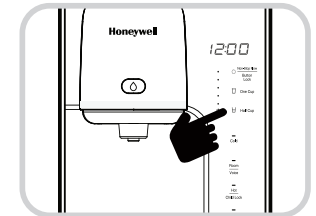

Fig. 8

## 6. INSTRUCTIONS FOR OPERATING YOUR WATER PURIFIER

### BUTTON LOCK FUNCTION

The purpose of this function is to prevent the random use by children as well as to enable to clean the product. If this function is selected, the input of all the buttons will be blocked.

1. Press the Non-Stop Flow/Buttons Lock button for three (3) seconds in the Waiting Status to select the Button Lock. The Voice Guide will say "selecting button lock" "button lock selected" (Fig. 9).
  - If a button is pressed during Button Lock status, the word "Loc\_" will be displayed and the Voice Guide will say "button is being locked".
  - To release the Button Lock status. The Voice Guide will say "cancelling button lock" and the word "Un\_Loc" will be displayed. The Voice Guide will say "button lock canceled".

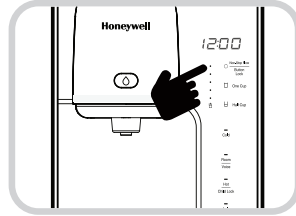

Fig. 9

### CHANGING VOICE VOLUME

1. Press the Energy Save/Clock (Setup) button for three (3) seconds in the Waiting Status. The Voice Guide will say "selecting user setting mode" "user setting mode, please set function by pressing the illuminated button".
  - The product will be in the User Setting mode.
2. Set the Voice Volume Step by pressing the Room water/Voice button. (Fig. 10).
  - Each time the button is pressed, it will change one he previously set voice level.  
Example: Step 4 → Step 5 → OFF → Step 1 → Step 2
  - For maximum volume select Step 5.
  - To cancel the Voice Guide, select OFF.
3. Select the desired voice volume and save it by pressing the Energy Save/Clock (Setup) button.
  - The Voice Guide will say "setup completed".

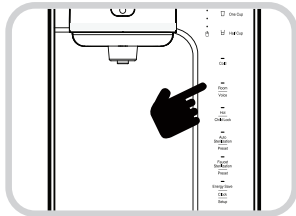

Fig. 10

### MOOD LAMP FUNCTION

1. Press the Energy Save/Clock (Setup) button for three (3) seconds in the Waiting Status. The Voice Guide will say "selecting user setting mode" "user setting mode, please set function by pressing the illuminated button".
  - The product will be in the User Setting mode.

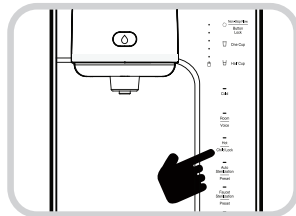

Fig. 11

## 6. INSTRUCTIONS FOR OPERATING YOUR WATER PURIFIER

2. Select the Mood Lamp function by pressing the Hot/Hot Water Lock button. (Fig. 11).
  - Each time the button is pressed, the Display will repeat showing ON and OFF.  
Example: ON → OFF → ON → OFF →
3. Select ON or OFF of the Mood Lamp and save it by pressing the Energy Save/Clock (Setup) button.
  - The Voice Guide will say "setup completed".

### COLD WATER CIRCULATING PUMP FUNCTION (LOW NOISE MODE)

The purpose of this function is to reduce the noise of the cold water circulating pump, however cooling time may take longer.

1. Press the Energy Save/Clock (Setup) button for three (3) seconds in the Waiting Status. The Voice Guide will say "selecting user setting mode" "user setting mode, please set function by pressing the illuminated button".
  - The product will be in the User Setting mode.
2. Select the Cold Water Circulating Pump function by pressing the Automatic Sterilization/Preset button. (Fig. 12).
  - Each time the button is pressed, the Display will repeat showing ON and OFF.  
Example: ON → OFF → ON → OFF →
3. Select ON or OFF of the Cold Water Circulating Pump and save it by pressing the Energy Save/Clock (Setup) button.
  - The Voice Guide will say "setup completed".

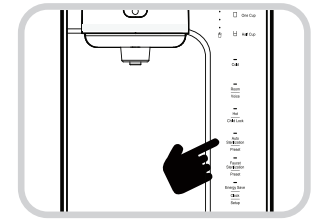

Fig. 12

### TIME SETUP

1. Press the Energy Save/Clock (Setup) button for three (3) seconds in the Waiting Status to put the unit in the User Setting mode.
2. After the unit is in the User Setting mode, press the Energy Save/Clock (Setup) button again. (Fig. 13).
  - The unit will be in the Time Setting mode.
  - The Voice Guide will say "sterilization reservation and presentime setting mode".
3. To set the hour press the Room water/Voice button.
4. To set the minute press the Hot/Hot Water Lock button.
5. To save the time press the energy Save/Clock (Setup) button.
  - The Voice Guide will say "setup completed".

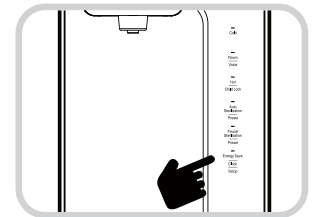

Fig. 13

## 6. INSTRUCTIONS FOR OPERATING YOUR WATER PURIFIER

### DRAINAGE FUNCTION

The purpose of this function is to drain all the water from the tank inside the unit.

1. Press the Energy Save/Clock (Setup) button for three (3) seconds in the Waiting Status to put the unit in the User Setting mode. The Voice Guide will say "selecting user setting mode" "user setting mode, please set function by pressing the illuminated button".
2. After the unit is in the User Setting mode, press the Non-Stop Flow/Button Lock button. (Fig. 14).
  - The Voice Guide will say "start draining" and the product will start the drainage function.
  - The Display Panel will show the drainage progress.
3. When the drainage has ended, the Voice Guide will say "draining completed" and the unit will return to Waiting Status.
4. If the Non-Stop Flow/Button Lock button or the Out Flow button are pressed again during the drainage, the process will end abruptly. This may cause water to remain inside the Tank.

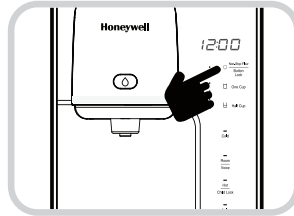

Fig. 14

## 7. STERILIZATION AND FILTER REPLACEMENT FUNCTIONS

### AUTOMATIC STERILIZATION PRESET FUNCTION

The purpose of this function is to sterilize the inner tubes as well as the tank of the unit.

1. If the Automatic Sterilization/Preset button Display Lamp is ON in the Waiting Status, the Automatic Sterilization Preset function is set to be used.
2. Press the Automatic Sterilization/Preset button if the Automatic Sterilization/Preset button Display Lamp is OFF. (Fig. 15).
  - The Voice Guide will say "auto sterilization setup completed".
  - The Automatic Sterilization/Preset button Display Lamp will turn ON.
3. To cancel the Automatic Sterilization Preset, press the Automatic Sterilization/Preset button while the Automatic Sterilization Preset function is set to be used.
  - The Voice Guide will say "auto sterilization cancelled".
  - The Automatic Sterilization/Preset button Display Lamp will turn OFF.

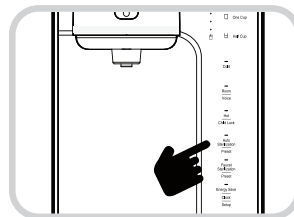

Fig. 15

## 7. STERILIZATION AND FILTER REPLACEMENT FUNCTIONS

### CHANGING AUTOMATIC STERILIZATION PRESET TIME

Default recommended cycle is set to 5 days at 03:00 am. This means the unit will run the sterilization process every 5 days at 03:00 am. User may change the cycle time between 3 and 10 days.

**NOTE:** The unit will consume more energy if running the cycle time more often.

1. Press the Energy Save/Clock (Setup) button for three (3) seconds in the Waiting Status to put the unit in the User Setting mode. (Fig. 16). The Voice Guide will say "selecting user setting mode" "user setting mode, please set function by pressing the illuminated button".
2. After the unit is in the User Setting mode, press the Energy Save/Clock (Setup) button again.
  - The unit will be in the Time Setting mode.
  - The Voice Guide will say "sterilization and preset time setting mode" "please set the reservation time and preset time by pressing the illuminated button".
3. To set the sterilization preset cycle press the Automatic Sterilization/Preset button. The Voice Guide will say "sterilization cycle setting mode" "please change sterilization cycle by pressing the blinking button then press the setup button".
4. To set the sterilization preset time press the Faucet Sterilization/Preset button. The Voice Guide will say "sterilization cycle setting mode" "please change sterilization cycle by pressing the blinking button then press the setup button".
5. To save the sterilization preset cycle and the time, press the Energy Save/Clock (Setup) button.
  - The Voice Guide will say "setup completed".

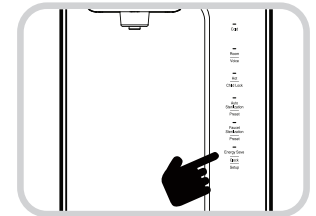

Fig. 16

### INSTANT AUTOMATIC STERILIZATION FUNCTION

The purpose of this function is to run the Automatic Sterilization without using the Automatic Sterilization Preset. The unit will perform a following process such as drainage of the sterilizing water, rinsing, or water input as the case may be, and a certain amount of time will elapse until the product is in the Waiting Status to dispense water.



## 7. STERILIZATION AND FILTER REPLACEMENT FUNCTIONS

- Both the sterilization method as well as the time needed for the sterilization are the same as the preset sterilization.
  - Immediate sterilization will not take place if the unit is dispensing cold, hot or room temperature water.
1. Press the Automatic Sterilization/Preset button for three (3) seconds in the Waiting Status. (Fig. 17). The Voice Guide will say "selecting auto sterilization" "to cancel press the illuminated button" (Auto Sterilization/Preset).
    - The unit will immediately start the automatic sterilization and the Voice Guide will say "start auto sterilization".
    - The Automatic Sterilization/Preset button Display will turn ON and the sterilization progress will be displayed.
  2. To cancel the sterilization operation press the Automatic Sterilization/Preset button during the automatic sterilization.
    - The Voice Guide will say "auto sterilization cancelled" and the sterilization cancellation will take place.

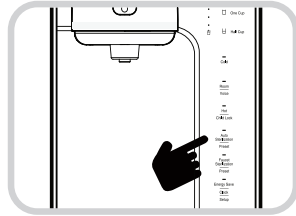

Fig. 17



### FAUCET STERILIZATION PRESET FUNCTION

This function is set by default to run every five (5) days at 03:00 am together with the Automatic Sterilization Function. The Faucet Sterilization Preset Function will take place as long as the Sterilization Cup is placed underneath the Faucet with the indicating arrow facing inwards. User may change the preset time by increments of one hour.

1. If the Faucet Sterilization/Preset button Display Lamp is ON in the Waiting status, the Faucet Sterilization Preset function is set to be used.
2. Press the Faucet Sterilization/Preset button if the Faucet Sterilization/Preset button Display Lamp is OFF. (Fig. 18).
  - The Voice Guide will say "faucet sterilization reservation selected" "please change the reservation time by pressing the blinking button, then press the setup button".
3. Select the desired preset time by pressing the Faucet Sterilization/Preset button.
  - Each time the Faucet Sterilization/Preset button is pressed, time will change by one hour.
4. After selecting the desired Faucet Sterilization Preset time, save the preset time by pressing the Energy Save/Clock (Setup) button. The Voice Guide will say "faucet sterilization function completed".
  - The Faucet Sterilization/Preset button Display Lamp will turn ON.

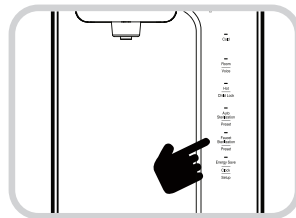

Fig. 18

## 7. STERILIZATION AND FILTER REPLACEMENT FUNCTIONS

- The Display Panel will show the sterilization cancellation status. If canceled too soon the display panel will show the clock on the Waiting Status.

### INSTANT FAUCET STERILIZATION FUNCTION

This function will sterilize the Faucet. When using this function make sure to place the Sterilization Cup underneath the Faucet.

1. Place the Sterilizing Cup below the Faucet with the indicating arrow facing inwards. The Voice Guide will say "sterilization cup detected" (Fig. 19).
2. Press the Faucet Sterilization/Preset button for tree (3) seconds in the Waiting Status (Fig. 20). The Voice Guide will say "selecting user setting mode" "user setting mode, please set function by pressing the illuminated button".
  - The product will immediately start the faucet sterilization and the Voice Guide will say "start faucet sterilization" "start sterilized water making".
  - The Faucet Sterilization/Preset button Display Lamp will turn ON and the sterilization progress will be displayed.
  - When the process is completed the Voice Guide will say "faucet sterilization completed".
3. To cancel the sterilization process, press the Faucet Sterilization/Preset button during the faucet sterilization.
  - The Voice Guide will say "faucet sterilization cancelled" and the sterilization cancellation will take place. The Display Panel will show "Stop".
  - When the faucet sterilization has been cancelled, hot water will come out through the faucet to clean the faucet, therefore, DO NOT REMOVE the Sterilizing Cup.
  - Remove Sterilizing Cup and dispose the water in it.

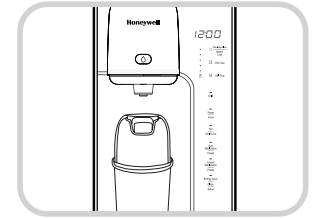

Fig. 19

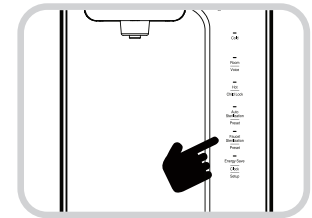

Fig. 20

### CLEANING FILTERS AUTOMATICALLY WHEN REPLACING FILTERS

1. Press the Energy Save/Clock (Setup) button for three (3) seconds in the Waiting Status to put the unit in the User Setting mode. (Fig. 21). The Voice Guide will say "selecting user setting mode" "user setting mode, please set function by pressing the illuminated button".
2. After the unit is in the User Setting mode, press the Out Flow button. (Fig. 22).
  - The Voice Guide will say "start auto filter cleaning" and the product will automatically clean the filters.
  - The Display Panel will show the automatic cleaning time.

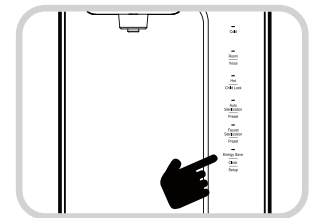

Fig. 21

## 7. STERILIZATION AND FILTER REPLACEMENT FUNCTIONS

- When the automatic filter cleaning is completed, the Voice Guide will say "auto filter cleaning completed" and the unit will return to Waiting Status and dispense water.
- To cancel the Automatic Filter Cleaning function, press the Out Flow button during the automatic filter cleaning.
  - The Voice Guide will say "auto filter cleaning stopped".
  - The time needed for the automatic filter cleaning will vary according to the temperature of the tap water, from 5 to 10 minutes.

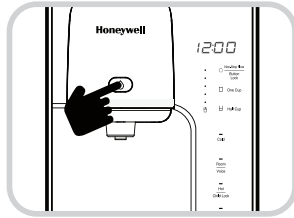

Fig. 22

## 8. TRAY CLEANING

- Disassembly the Tray
  - Hold the Tray and pull it forward.
  - Pull the Tray slowly with both hands otherwise water may pour out. (Fig. 1).
- Disassembly the Tray Grille
  - Disassemble the Tray, hold and lift the Grille at the top of the Tray and disassemble. (Fig. 2).
- Cleaning the Tray
  - Discard the collected water and dry the remaining moisture with a soft cloth. (Fig. 3).

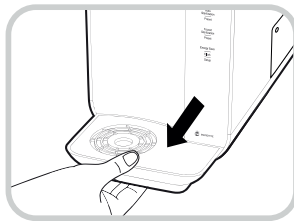

Fig. 1

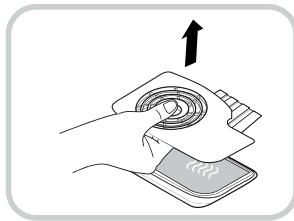

Fig. 2



Fig. 3

## 8. TRAY CLEANING

- Assembly the Tray
  - Finish the cleaning and reassemble again in the reverse order. (Fig. 4).

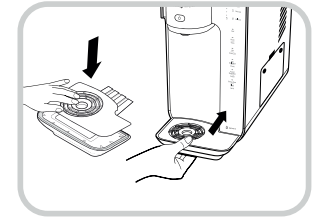

Fig. 4

## 9. FILTERS REPLACEMENT

The filters should be replaced and cleaned according to the replacement cycle and the Cleaning Filters Automatically When Replacing Filters described in pages 21 and 22 of this manual. Failure to do so may reduce the purification performance or cause bad odor.

**WARNING:** Always use original filters (part No. HWPF201AB), otherwise it may reduce purification performance, cause strange water taste, water leak or malfunction of the product. The manufacturer will not undertake any responsibility from damages or incidents resulting from using non original filters. Failing to use original filters will void the manufacturer's warranty.

The filter replacement cycle is determined based on drinking water of 2.64 gallons (10 liters) average per day in a house of four persons, but may be affected by the condition of the tap water.

Expected replacement cycle for both filters is 4 months each.

- Close the Water Inlet Valve. (Fig. 1)
- Remove the residual water pressure in the pipe.
  - Place a cup under the Faucet, press the Room water/Voice button, and then press the Out Flow button for about five (5) seconds. (Fig. 2) (Fig. 3).

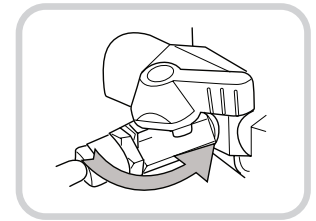

Fig. 1

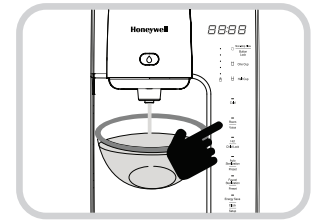

Fig. 2

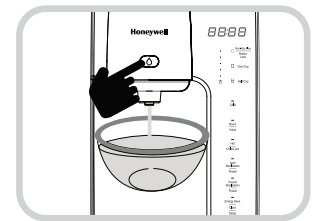

Fig. 3



## 9. FILTERS REPLACEMENT

3. Disconnect the power supply (Fig. 4).

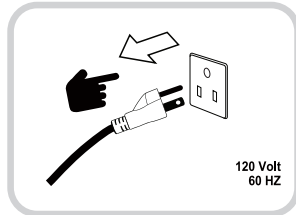

Fig. 4

4. Remove two screws from the Filter Compartment Door using a Phillips screwdriver (not included). (Fig. 5).

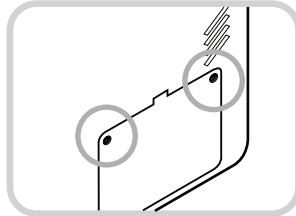

Fig. 5

5. Remove one screw (1) of the Transparent Filter Cover with a Phillips screwdriver (not included) and remove the Cover by pressing the hook (2). (Fig. 6).

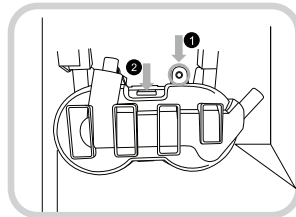

Fig. 6

6. Disassemble the Connector (1) by lifting it upward by hand and disassemble the Connector (2) by lifting it upward also by hand (fig. 7). Do not use tools to pull out the Filters.

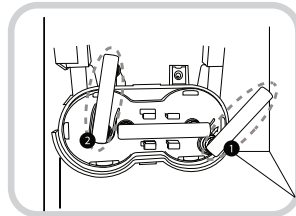

Fig. 7

7. Pull out the Filters by hand and disassemble the Inter Filter Connector that connects Filter (1) to Filter (2). (Fig 8).

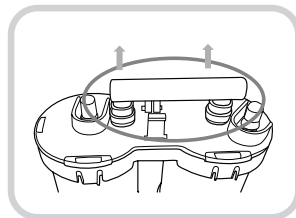

Fig. 8

## 9. FILTERS REPLACEMENT

8. Remove the Transparent Filter Holder by lifting the small hooks and replace the existing Filters for the new ones (Fig. 9).

**CAUTION:** Make sure to replace the Filters in their corresponding place. Filter 1 below the number 1 indicated in the Transparent Filter Holder and Filter 2 on the opposite side.

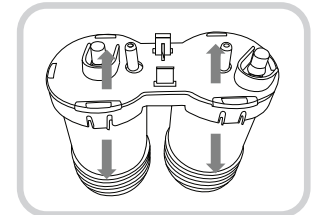

Fig. 9

9. Reinsert the Filters inside the unit, reconnect the Inter Filters Connector, Connectors 1 and 2 and fasten the Transparent Filter Cover with the screw using a Phillips screwdriver (not included).

- If the Filter connectors are not properly fitted, there is a risk of water leak. (Fig. 10) (Fig. 11).

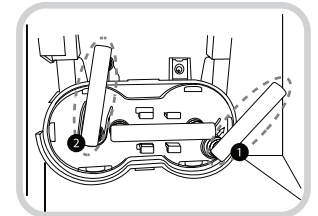

Fig. 10

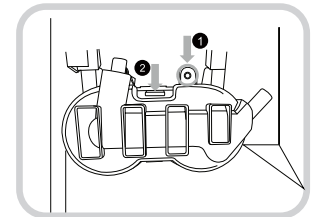

Fig. 11

10. Close the Filter Compartment Door at the bottom right of the product and fix it by tightening the screws.

- You need to accurately fit the groove at the bottom to insert it smoothly. (Fig. 12.)

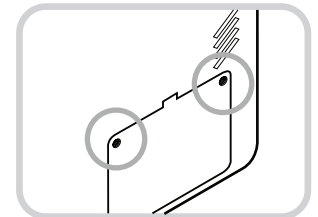

Fig. 12

## 9. FILTERS REPLACEMENT

11. Open the Water Inlet Valve, connect the power supply (Fig. 13) (Fig. 14) and clean the Filters using the Cleaning Filters Automatically When Replacing Filters function described in page 21.

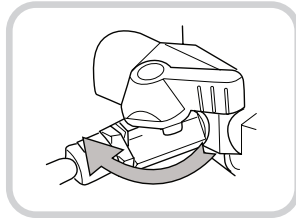

Fig. 13

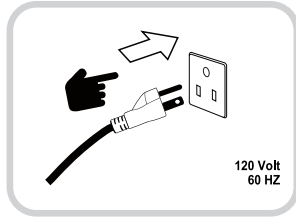

Fig. 14

## 10. MAINTENANCE

### CAUTION:

- Before cleaning the product, set the Button Lock to prevent an incorrect operation during cleaning.
- DO NOT rub or use any type of cleaning agent to clean the parts. Never clean the parts with flammable fluids as the fumes may create a fire hazard or explosion.
- Never use corrosive elements or any chemicals to clean this product.
- If the product has not been used in a long time, drain completely the water in the Tank, fill the Tank with water and drain it again before use.

### Cleaning the surface of your Water Purifier

- To clean the surface of the product, use a soft cloth with warm water. Avoid abrasive cleaners or hard materials to prevent damage and or scratches to the unit.
- Clean the tray regularly. Please refer to 7. TRAY CLEANING.

### Replacing the Filters

- Replace and clean the Filters every 4 months.
- Please contact your local distributor to purchase new Filters.
- When replacing your filters you should clean the entire water filtration system as explained in Section 8. Filters Replacement and Automatic Filter Cleaning.
- Filter longevity may vary based on local water conditions.

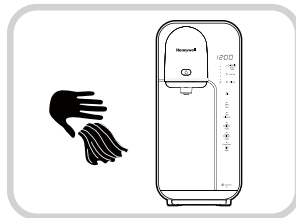

## 11. TECHNICAL SPECIFICATION

<b>Model No.</b>	HWP2013W
<b>Rated Voltage</b>	AC 120V / 60Hz
<b>Power Consumption</b>	Hot 1350W / Cold 110W
<b>Volume Capacity</b>	Cold: 1.3L / Hot: Instant heating system
<b>Water Flow</b>	Cold: 1,100-1,200(cc/min) / Room, Hot: Direct Flow Type
<b>Natural Plus Filter Material</b>	Charcoal, Activated Carbon, Nylon-mesh, Ceramic Ball
<b>Nano Positive Plus Filter Material</b>	Polypropylene, Polyester, Polyamine, Carbon
<b>Filter Life</b>	(105) Gallons) 1400 Liters. Approx. 4 month each
<b>Water Pressure</b>	19.97 PSI      Install using a pump to increase water pressure 19.97-28-43 PSI      Install without external valve 28.43-113-71 PSI      Proper Water Pressure
<b>Maximum Water Pressure</b>	113.71 PSI
<b>Min-Max Operating Temp.</b>	41°F - 104°F (5°C - 40°C)
<b>Recommended Water Temps.</b>	41°F - 77°F (5°C - 25°C)
<b>Net Weight</b>	19.1lb (8.7Kg)
<b>Dimensions</b>	7.08"(W) x 16.25"(D) x 15.19"(H) 180mm (W) x 413mm (D) x 386mm (H)

## 12. PERFORMANCE DATA SHEET

- While testing was performed under standard laboratory conditions, actual performance may vary depending on water pressure, temperatures and other substances, which may be found in your water.
- It is recommended that, before installing a water purifier, you have your water supply tested to determine your actual water treatment needs.
- Substances removed by the purifier may not be in all users water supply
- Filtration performance is from the water that passes through the filters.
- Performance data as per testing done by Korea Environment & Water Works Institution which is accredited by Korea Laboratory Accreditation Scheme (KOLAS) in accordance to Standard ISO/IEC 17025 : 2005

### Inner Tank Sterilization, Bacteria Reduction

Items	Unit	Result			Remark
		The synthesis water	The passed water	Removal Rate (%)	
E.coli	CFU/mL	15000	ND	100	-
Staphylococcus aureus	CFU/mL	22000	ND	100	-
Pseudomonas aeruginosa	CFU/mL	8600	ND	100	-

- ND = Not Detected

### Filters Bacteria Reduction

Items	Unit	Prepared Water	Result			Remark
			The point of draining a sterile water (Removal rate)	The point of draining a washing water (Removal rate)	The point of full level (Removal rate)	
E.coli	CFU/mL	2500	ND(100%)	ND(100%)	ND(100%)	-
Staphylococcus aureus	CFU/mL	7200	ND(100%)	ND(100%)	ND(100%)	-
Pseudomonas aeruginosa	CFU/mL	4400	ND(100%)	ND(100%)	ND(100%)	-

- ND = Not Detected

## 12. PERFORMANCE DATA SHEET

### Inner Tubes Sterilization, Bacteria Reduction

Items	Unit	Prepared Water	Result	
			After completion of Sterilization mode (Removal rate)	Remark
E.coli	CFU/mL	2100	ND(100%)	-
Staphylococcus aureus	CFU/mL	1700	ND(100%)	-
Pseudomonas aeruginosa	CFU/mL	4400	ND(100%)	-

- ND = Not Detected

### External Faucet Sterilization, Bacteria Reduction

Items	Unit	Prepared Water	Result	
			After completion of Sterilization mode (Removal rate)	Remark
E.coli	CFU/mL	280	ND(100%)	-
Staphylococcus aureus	CFU/mL	190	ND(100%)	-
Pseudomonas aeruginosa	CFU/mL	320	ND(100%)	-

- ND = Not Detected

### Filter Chlorine Reduction

Items	Unit	Sterile Water	Result	
			After completion of Sterilization mode (Removal rate)	Remark
Available Free Residual Chlorine	mg/L	1.11	ND(100%)	-

- ND = Not Detected

## 12. PERFORMANCE DATA SHEET

### Filter Toxic Metals Reduction

Items	Unit	Standard	Result	Items	Unit	Standard	Result
Taste	----	Tasteless	Tasteless	1,1-Dichloroethylene	mg/L	0.003	ND
Odor	----	Odorless	Odorless	1,1,2-Trichloroethane	mg/L	0.0006	ND
Color	Degree	0.5	Below 0.1	Trichloroethylene	mg/L	0.003	ND
Turbidity	NTU	0.2	Below 0.02	Benzene	mg/L	0.001	ND
Cd	mg/L	0.0005	ND	1,1,1-Trichloroethane	mg/L	0.01	ND
Se	mg/L	0.001	ND	Dichloromethane	mg/L	0.002	ND
Pb	mg/L	0.001	ND	Cis-1,2-Dichloroethylene	mg/L	0.004	ND
As	mg/L	0.001	ND	Tetrachloroethylene	mg/L	0.001	ND
Zn	mg/L	0.3	ND	Epichlorohydrin	mg/L	0.1	ND
Fe	mg/L	0.03	ND	Vinyl acetate	mg/L	0.01	ND
Cu	mg/L	0.01	ND	Styrene	mg/L	0.002	ND
Na	mg/L	20	ND	1,2-Butadiene	mg/L	0.001	ND
Mn	mg/L	0.03	0.006	1,3-Butadiene	mg/L	0.001	ND
Cr6+	mg/L	0.005	ND	N,N-Dimethylaniline	mg/L	0.01	ND
Hg	mg/L	0.0001	ND	2,4-TDA	mg/L	0.002	ND
CN	mg/L	0.001	ND	2,6-TDA	mg/L	0.001	ND
NH <sub>3</sub> -N	mg/L	1	1.0	Formaldehyde	mg/L	0.008	0.054
NO <sub>3</sub> -N	mg/L	1	ND	B	mg/L	0.1	ND
F	mg/L	0.15	ND	Toluene	mg/L	0.07	ND
Cl-	mg/L	25	ND	Xylenes	mg/L	0.05	ND
Evaporative residue	mg/L	50	3	Al	mg/L	0.02	0.0114
ABS	mg/L	0.02	ND	Bisphenol A	mg/L	0.01	ND
Consumption of KMnO <sub>4</sub>	mg/L	1.0	0.3	Ni	mg/L	0.04	ND
Phenol	mg/L	0.0005	ND	Sb	mg/L	0.002	ND
Carbon chloride	mg/L	0.0002	ND	Ag	mg/L	0.01	ND
1,2-Dichloroethane	mg/L	0.0004	ND				

## 13. TROUBLESHOOTING GUIDE

**IF THE UNIT IS NOT WORKING PROPERLY, PLEASE REFER TO THE TABLE BELOW TO SOLVE MOST COMMON PROBLEMS**

Issue	Possible Cause	Solution
The water has bad taste and/or odor	<ul style="list-style-type: none"> <li>You have not used the unit a long time</li> <li>It might be time to replace the Filters</li> </ul>	<ul style="list-style-type: none"> <li>Drain the water inside the Cold Water Tank or use automatic sterilization</li> <li>Contact Customer Service to purchase Filters</li> </ul>
Does not dispense water	<ul style="list-style-type: none"> <li>Tap water does not flow smoothly</li> <li>Out Flow button was not pressed properly</li> <li>There is water under the product</li> <li>Time to replace the Filters</li> </ul>	<ul style="list-style-type: none"> <li>Open the Tap Water Valve, check if the Feed Tube is folded or check if water is cut off</li> <li>Press the Out Flow button properly</li> <li>Close the Tap Water Supply Valve, unplug the unit and contact Customer Service</li> <li>Contact Customer Service to purchase Filters</li> </ul>
Does not dispense cold water	<ul style="list-style-type: none"> <li>Cold Water tank capacity was completely dispensed.</li> <li>The Tap Water Supply Valve has not been opened</li> <li>Poor ventilation at the back of the product</li> </ul>	<ul style="list-style-type: none"> <li>Product needs time to cool again</li> <li>Check the tap Water Supply Valve</li> <li>Remove any objects blocking the back of the product.</li> <li>Move the unit to a place with good ventilation</li> </ul>
Hot water is lukewarm	<ul style="list-style-type: none"> <li>It is the first cup of hot water dispensed</li> </ul>	<ul style="list-style-type: none"> <li>When using the Instant Hot Water function for the first time, the first cup may not be as hot</li> <li>Check the temperature from the second cup</li> </ul>
Sudden decrease of Room Temperature water	<ul style="list-style-type: none"> <li>The Tap Water Supply Valve is not closed</li> <li>Time to replace the Filters</li> </ul>	<ul style="list-style-type: none"> <li>Open the Tap Water Supply Valve</li> <li>Contact Customer Service to purchase Filters</li> </ul>
Loud noise coming from the unit	<ul style="list-style-type: none"> <li>The unit is not placed on a leveled surface</li> <li>The unit is touching another object</li> <li>The tray is not assembled properly</li> </ul>	<ul style="list-style-type: none"> <li>Place the unit on a leveled surface</li> <li>Avoid contact with other objects</li> <li>Check that the tray is assembled properly</li> </ul>
Particles in the water	<ul style="list-style-type: none"> <li>Time to replace the Filters</li> </ul>	<ul style="list-style-type: none"> <li>Contact Customer Service to purchase Filters</li> </ul>
Water is leaking	<ul style="list-style-type: none"> <li>Connecting part defective</li> <li>There is humidity in the house</li> </ul>	<ul style="list-style-type: none"> <li>Close the Tap Water Supply Valve, unplug the unit and call Customer Service</li> </ul>

For any issue not shown on the table, please contact customer service: 1-855-687-2223

Do not attempt to disassemble the unit yourself. The manufacturer will not undertake any responsibility for damages or incidents resulting from disassembly. This action will void the manufacturer's warranty.